



Information Processing System

- DATA is a collection of independent and unorganized facts.
- INFORMATION is the processed and organized data presented in a meaningful form.
- DATA PROCESSING is the course of doing things in a sequence of steps.



Information Processing System

- COMPUTER is an electronic machine that follows a set of instructions in order that it may be able to accept and gather data and transform these into information.

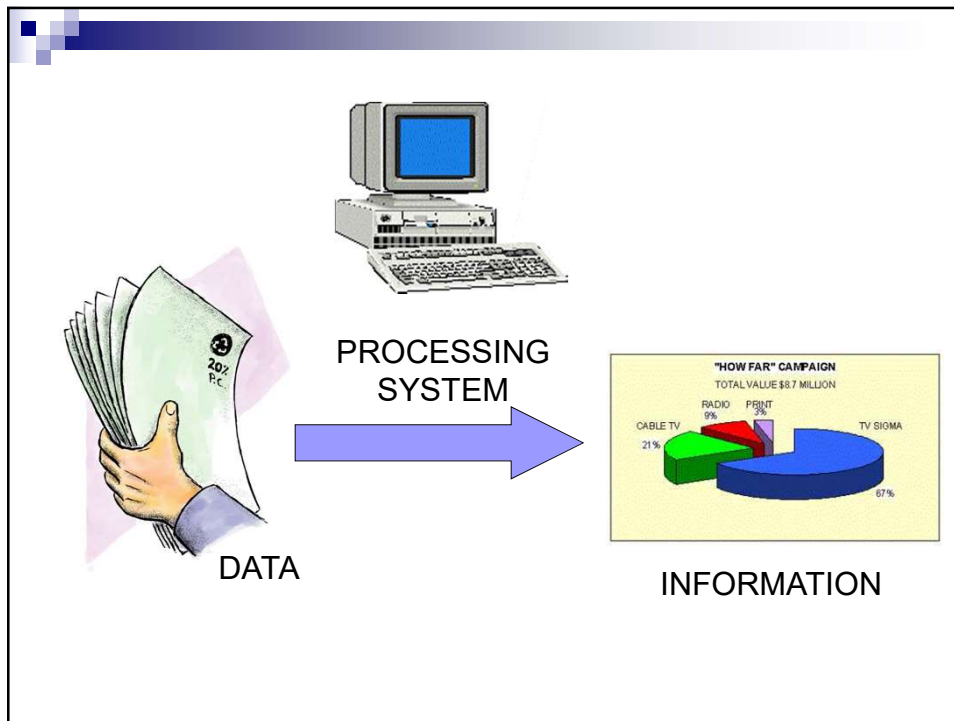

Functions of an Information Processing System

1. It accepts and gather data. (INPUT)
2. It processes data to become information. (PROCESSING)
3. It stores data and information. (STORE)
4. It presents information. (OUTPUT)

Three Major Components of an Information Processing System

- **HARDWARE** is the tangible part of a computer system.
- **SOFTWARE** is the non-tangible part that tells the computer how to do its job.
- **PEOPLEWARE** refer to people who use and operate the computer system, write computer programs, and analyze and design the information system.

Basic Units of Measurement

- **BIT** is a unit of information equivalent to the result of a choice between only 2 possible alternatives in the binary number system.
- **BYTE** is a sequence of 8 bits (enough to represent one character of alphanumeric data) processed as a single unit for information.

Basic Units of Measurement

- A byte can be used to represent a single character, which can be:
 - A letter
 - A number
 - A special character or symbol, or
 - A space

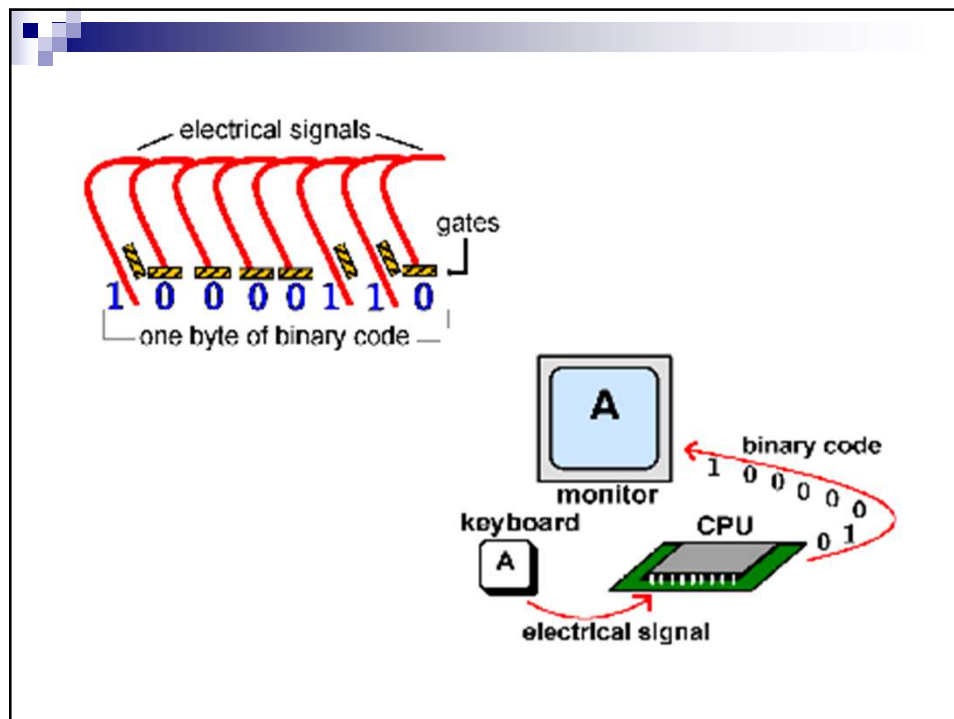

Basic Units of Measurement

- 1,000 bytes =1 kilobyte (K or KB)
- 1,000 KB =1 megabyte (MB)
- 1,000 MB =1 gigabyte (GB)
- 1,000 GB =1 Terabyte (TB)

BASIC PC HARDWARE

- **HARDWARE** is the tangible part of a computer system.

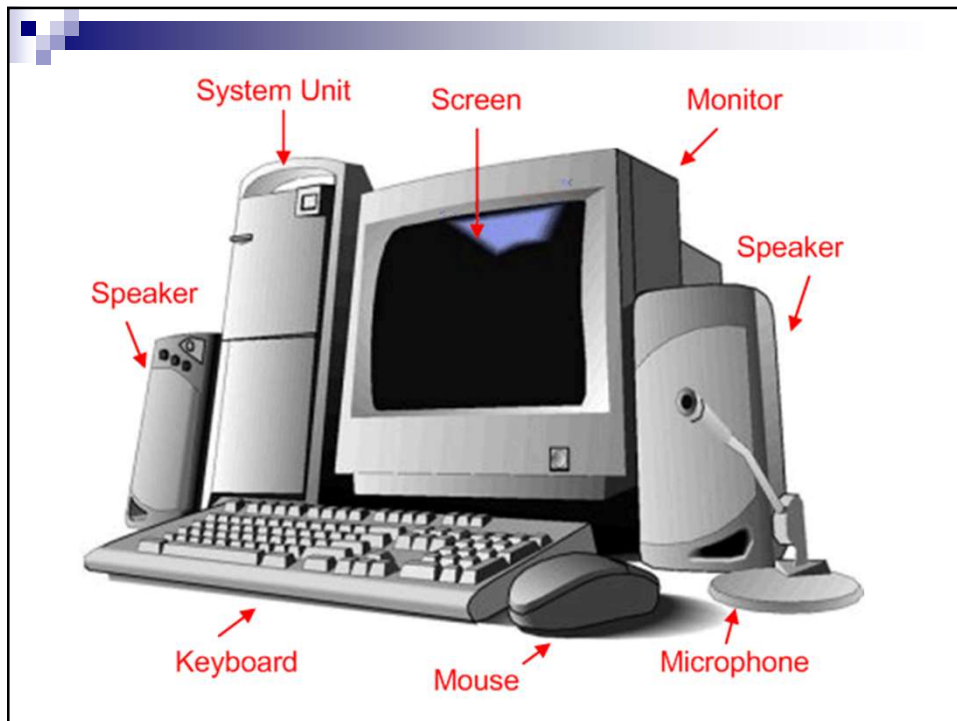

Basic hardware of a PC system

- Central Processing Unit (CPU)
- Memory Unit
- Input Devices
- Output Devices
- Secondary Storage Devices

1. Central Processing Unit

- Brain of the computer.
- It directs and controls the entire computer system and performs all arithmetic and logical operations.

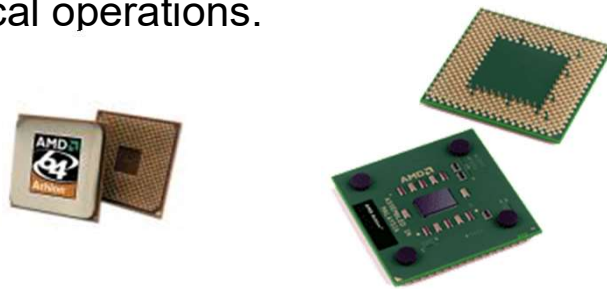

2. Memory Unit

- Where the programs and data are stored .
 - READ ONLY MEMORY (ROM) contains the pre-programmed computer instructions such as the Basic Input Output System (BIOS).
 - RANDOM ACCESS MEMORY (RAM) is used to store the programs and data that you will run. Exists only when there is power.

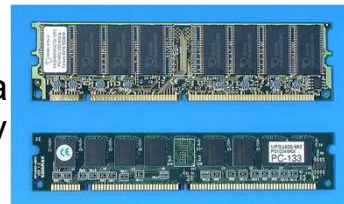

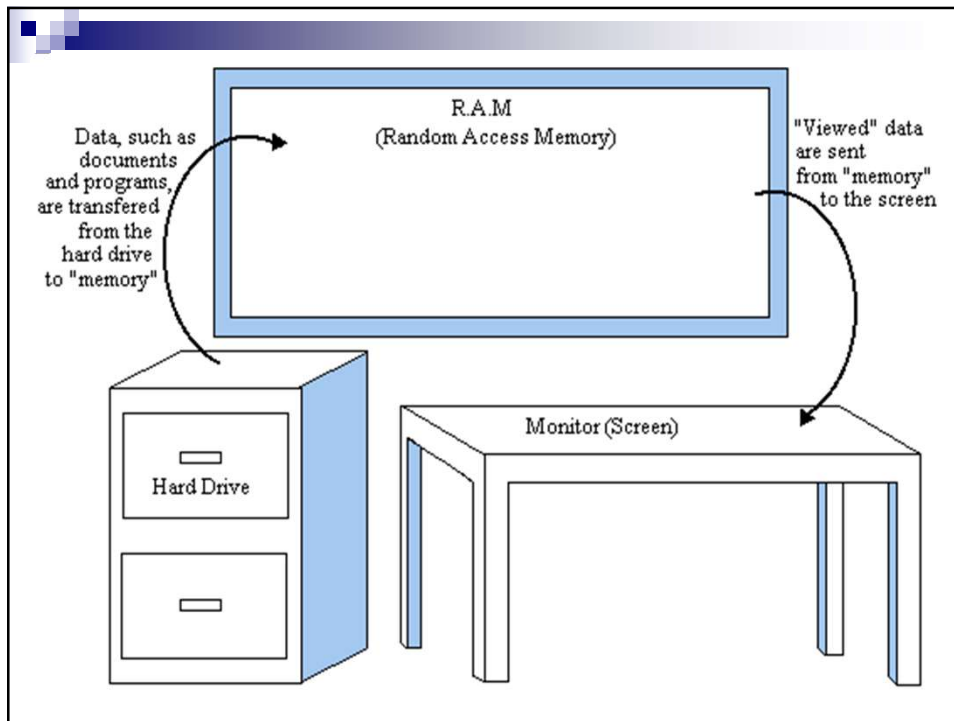

3. Input Devices

- Allows data and programs to be sent to the CPU.
 - Keyboard
 - Mouse
 - Joystick
 - Microphone
 - Webcam
 - Scanner
 - Monitor



Keyboard

- Traditional keyboards
- Flexible keyboards
- Ergonomic keyboards
- Wireless keyboards
- PDA keyboards



Two Types of Mouse

- **Mechanical** - a type of computer mouse that has a rubber or metal ball on its underside and it can roll in every direction.
- **Optical:** This type uses a laser for detecting the mouse's movement.



How a Mouse Hooks Up to a PC

- PS/2 Mouse

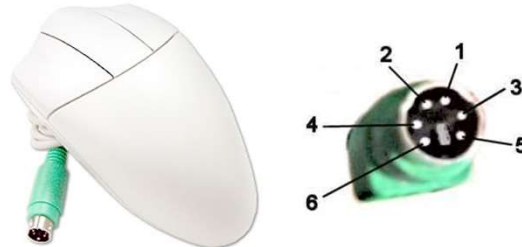

- Serial Mouse



- USB/Cordless Mouse

Other Pointing Devices

- Trackball



- Track point



- Touch pad



- Touch Screen



- Joystick – input device for computer games



- Light Pens – light-sensitive penlike device



- Stylus – penlike device commonly used with tablet PCs and PDAs.



Scanning Devices

- Optical scanners
- Card readers
- Bar code readers
- Character and mark recognition devices



Name	ACCOUNT NO.	DATE	DDMMYY
Address	Tel.	CHEQUE NO.	\$
City/Town	Postal Code		100 DOLLARS
MEMO			
CANADIAN WESTERN BANK Think Western® 10323 JASPER AVENUE EDMONTON, AB T5J 3N6			
⑆03089⑆030⑆ 60⑆123⑆456⑆7⑆			



Image Capturing Devices

- Digital Cameras



- Digital Video Cam



4. Output Devices

- Media used by the computer in displaying its responses to our requests and instructions.
- Monitor
- Audio Speakers
- Printer

Types of Monitor

- Cathode Ray Tube (CRT)
- Liquid Crystal Display (LCD)



Printers

- **IMPACT PRINTERS** uses pressure by physically striking the paper. Ex. Daisy wheel printers, line printers, dot matrix printers & band printers.
- **NON-IMPACT PRINTER** does not apply pressure on the paper but instead produces character by using lasers, ink spray, photography or heat.



5. Secondary Storage Devices

- Attached to the computer system to allow you to store programs and data permanently for the purpose of retrieving them for future use.
- Floppy disk, Hard disk, CD Rom

Floppy Disk

- The most common secondary storage device
- 3.5" disk – 1.44MB



High-Capacity Floppy Disks

- Floppy disk cartridges
- 3 ½ inches in diameter
- Stores more information
- Zip disks



Hard Disk Drive or Hard Disk

- Made of rigid materials unlike floppy disks
- Holds a greater amount of data



Optical Discs

- A standard part of modern desktop machines, especially used for multimedia purposes and preferred in loading applications.



Kinds

- Blue Ray Disk – 40G
- Digital Versatile Disk
 - DVD-R – write once, 3.95G
 - DVD RW – rewritable, 3G
 - Single Layer and Double Layer
- Compact Disk
 - CD-R – write once, 650MB
 - CD-RW – rewritable, 700MB



Optical Drives

- | | |
|--------------|-----------------------------------|
| ■ CD-ROM | read CDs |
| ■ CD-Writer | read/write CDs |
| ■ DVD-Combo | read/write CDs, read DVD |
| ■ DVD Writer | read/write CDs
read/write DVDs |

Other Secondary Storage

- Solid-State Storage

- No moving parts
- Flash memory cards



- USB flash drives



Parts that Build Up A System Unit

- Casing or cover
- Power Supply
- Motherboard
- Microprocessor
- Memory
- Video Card
- Sound card
- Floppy disk drive
- Hard disk drive
- CD-ROM drive
- MODEM

Casing or cover

- The box or outer shell that houses most of the computer, it is usually one of the most overlooked parts of the PC.
- Protects the computer circuits, cooling and system organization.



Power Supply

- Responsible for powering every device in your computer.
- Parts of a Power supply:
 - Disk drive connectors
 - Motherboard connector
 - Power supply fan
 - Power switch
 - Input voltage selector
 - Cover
 - Power plugs receptacle



Motherboard

- The physical arrangement in a computer that contains the computer's basic circuitry and components.
- Components are:
 - Microprocessor
 - (Optional) Coprocessors
 - Memory
 - Basic Input/Output System (BIOS)
 - Expansion Slot
 - Interconnecting circuitry

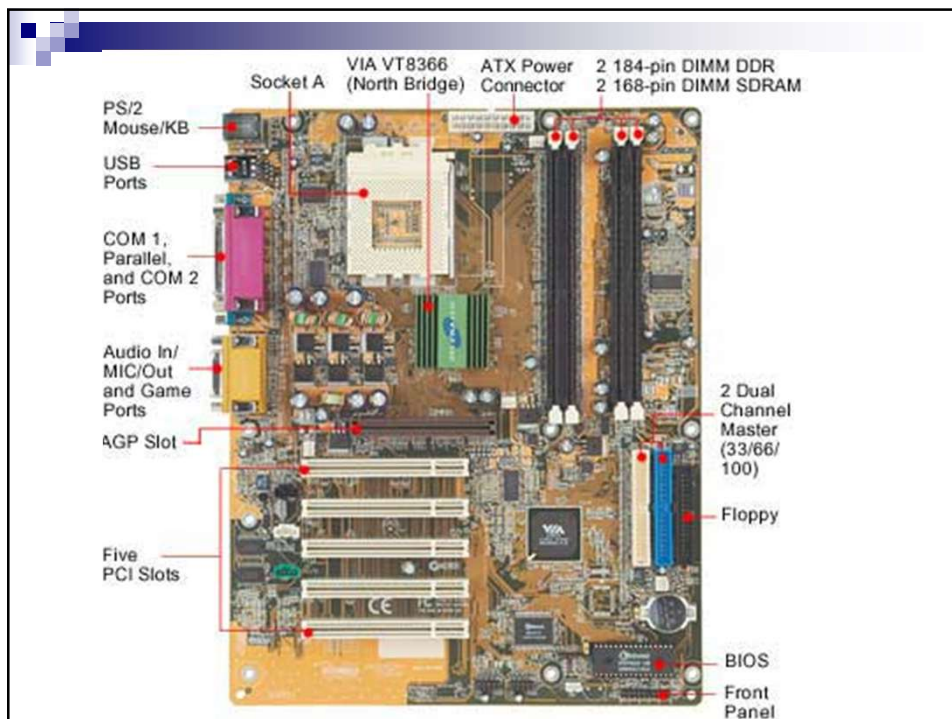

Expansion Slots

- Graphic cards
- Sound cards
- Modem cards
- Network interface cards/network adapter

Software

- Instructions that tell the computer how to process data into the form you want.
- Software and programs are interchangeable.
- Two major types:
 - System and Applications

2 Kinds of Software

1. System Software enables the application software to interact with the computer hardware.
 - Operating Systems are programs that coordinate computer resources, provide an interface between users and the computer; and run applications.
 - Utilities perform specific tasks related to managing computer resources.
 - Device drivers are specialized programs designed to allow particular input or output devices to communicate with the rest of the computer system.

Functions of a System Software

- Managing resources (memory, processing, storage, and devices like printer).
- Providing user interface
- Running applications



2 Kinds of Software



2. Applications Software - provides the real functionality of a computer. It help you use your computer to do specific types of work.
 - Basic Applications, widely used in all career areas.
 - Specialized Applications, more narrowly focused on specific disciplines and occupations.



Disk Operating System

- DOS was the first widely installed operating system for personal computers.
- Command-driven

MS-DOS Commands

- A COMMAND is the name of a special program that makes your computer carry out a task.

Graphical User Interface (GUI)

- Thru GUI, users can interact directly with the operating system.
- Microsoft Windows
- Icons, Menus, Dialog boxes

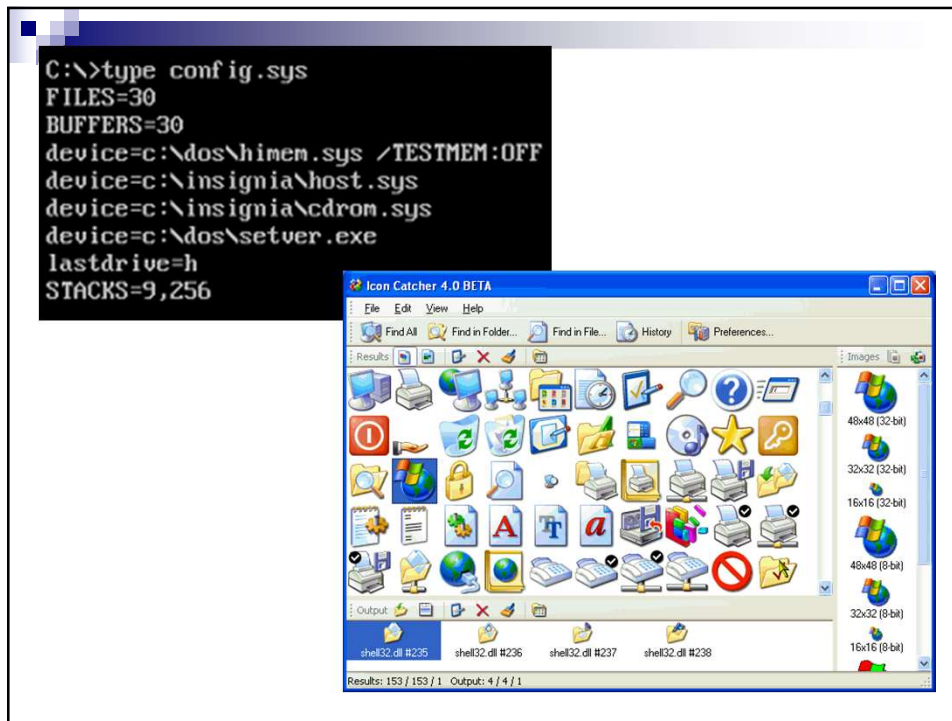

FILES

- FILE is simply a collection of information that you store on a disk or diskette.
- Must have a unique name
- Two parts: the filename and extension separated by a period.



EXTENSIONS

- Use extension to make your filenames more descriptive.
 - .DOC – word documents
 - .XLS – excel documents
 - .PPT – powerpoint documents



DIRECTORIES

- One way of organizing the files on your computer Hard Disk
- ROOT – one basic directory
- Subdirectories

